



RISO ME 9350

Streamline your work with the benefits of two-colour printing.



1 OR **2**
COLOUR
PRINTING

Make your ideas stand out.

Communicate yourself with more clarity.

Double your colours for double the impact and immediacy in your documents. ME series printers provide the power of two-colour printing at just a single pass, making it easy and convenient to give your documents a professionally finished look.

RISO quality lets you communicate your ideas quickly, beautifully, easily, and usefully. And the highly durable ME series take various type of paper, making them more versatile than ever.



RISO ME 9350

High-quality, ultra-high-speed
1 or 2 colour printing for everyone:
RISO's revolutionary ME series

1



SIÊU NHANH



SIÊU NHANH

High Productivity

**Print more copies,
in less time, at less cost.**



A two-drum layout for high-speed two-colour printing.

The RISO ME9350 digital duplicator comes with dual drums. Compared to using single-colour digital duplicators for two-colour output, this reduces ink-drying time and the tasks of reinserting paper and changing drums. One simple action gives you the high-speed colour printing you need. (Single-colour printing using one drum is also possible.)



Single-colour digital duplicator

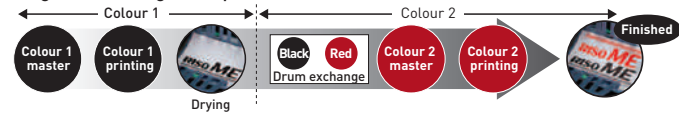

The RISO ME9350



Up to 150 pages a minute in two crisp colours.

The RISO ME9350 features an adjustable five-speed function for printing between 60 and 120 pages per minute. It also has a high-speed mode that prints at a maximum speed of 150 pages per minute, or approximately 750 pages in five minutes.

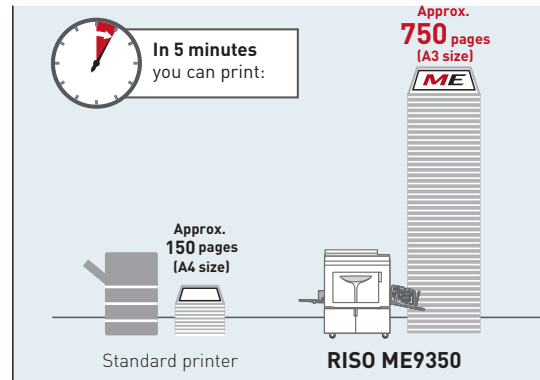

Note: Comparison of the RISO ME9350 (150 pages per minute) and a standard printer (30 A4-size pages per minute).

The larger the job volume, the lower the operating cost.

The RISO ME9350 first creates a master copy of the original document, from which prints are made. The printing cost per copy of a document goes down with every print, making the RISO ME9350 highly economical for large-volume printing. You can use the optional "A4/letter drum" to print these popular sizes even more efficiently to save master usage, holding down running costs to a minimum.

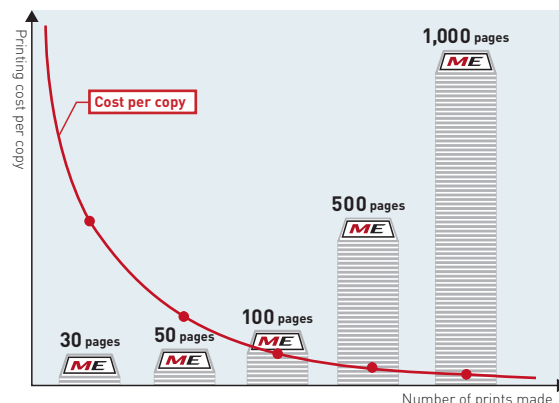

High Quality

Sharp, rich images give your ideas impact on the page.



High-resolution 600 dpi scanning and printing gives clear output.

The RISO ME9350 digital duplicator both scans and prints information at a high resolution level of 600 dpi, producing sharp, clear images of even fine lines and small characters. The model uses the RISO Master E Type HG, with a two-layer ink-permeable sheet adding an extra fine-filter layer to the standard layer, enabling even ink transfer to the paper. It can also reproduce subtle colour gradations, enabling users to print clear copies of photos, shaded areas of images, and documents written in pencil.

RISO Master E Type HG cross-section

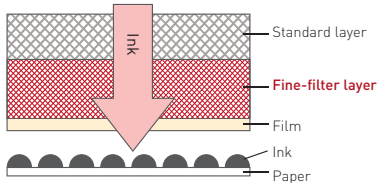

Magnified view of master

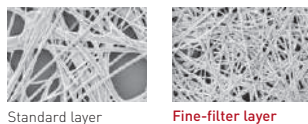

RISO ME 9350 2-COLOUR PRINTING

A rainbow of variety for your work.

The machine's colour drum accommodates a wide variety of inks in 21 standard colours, 50 custom colours, plus special order-made colours that can give corporate logos an extra-special look. This huge selection of colours lets you add powerful impact to your documents. And because the ink is made by RISO, you're assured of the highest quality results. Front panel access makes switching the drum quick and easy to change colour, too.

Red	Bright Red	RISO-Marine Red	Burgundy
Brown	Yellow	Green	Teal
Blue	Medium Blue	RISO-Fed. Blue	Purple
Flat Gold	Orange	Crimson	Hunter Green
Gray	Light Gray	Fluorescent Pink	Fluores. Orange
		Gold	

[Custom colours]



Note: The actual colours may differ from the samples shown above.



Versatile printing on different paper types.

The RISO ME9350 lets you use a wide range of paper types, giving you the perfect option for your job every time. Advertising fliers and leaflets, announcements, newsletters, tickets, business applications such as letterheads, reports and business cards, lesson materials, invitations, coupons; the list just goes on and on. If you can print it, it's sure to look better with a second colour.

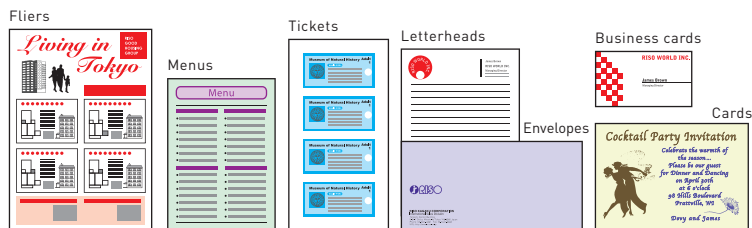



SIÊU NHANH

Ease of Operation

Controls designed with ease of use in mind.



Print from hard copies, a computer, a USB drive, or stored data.

For users who create originals on a PC, the printer driver software automatically handles colour separation when the data is sent to the printer. Even if the printer is not connected to your PC or network, you can still print directly from your data file. Just save the file to a USB flash drive, connect the flash drive to the printer via the built-in USB port, and you're ready to print. And of course you can print from copies scanned directly into the unit.

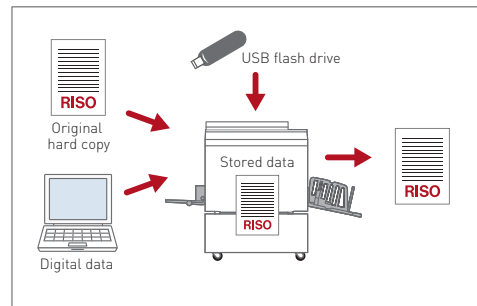

Easier master-making with "Easy 2-colour" for original hard copy.

The ME series "Easy 2-colour" process not only makes it quick and easy to create two-colour masters, it also offers you a choice of how to do it so you can select the method you find easiest or the one that's most suitable for your print job.

Red and black original

A red and black original gives the simplest master-making process. Just set your original and scan—the ME series automatically does the colour separation for you.

Handwritten separation

With a one-colour original, you can write the data you want printed in the second colour in pencil. Then you simply scan and the colours are separated automatically.

Area separation

On a one-colour original you just circle the areas for printing in the second colour. Then scan your marked original and the colour separation process happens automatically.

Separation sheet

With area separation, you have to mark your original. If you don't wish to write on your original, simply circle the area for printing in the second colour on a separate sheet and scan twice for colour separation.

RISO Editor

The RISO Editor lets you directly specify on the touch panel which areas should be in which colour, or even move photos, illustrations, or blocks of text.

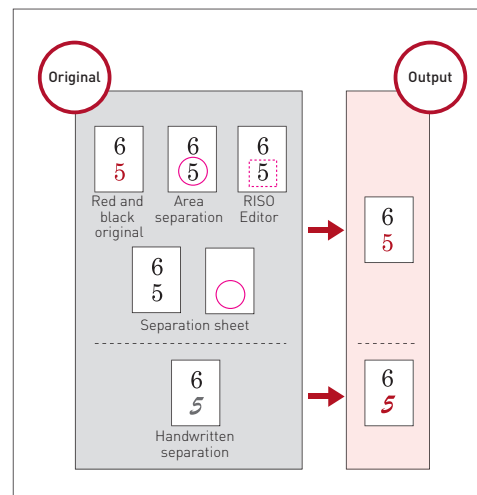

The layout function saves paper by consolidating information on a single page.

With "Multi-up" function, documents that run into several pages can be consolidated into fewer pages and in an easier-to-read format, thus reducing the amount of paper required for printing.

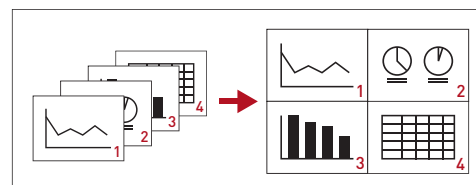

Convenient Functionality

The features you need to make your job even easier.



Advanced print functions for even more convenient use.

The "Programmed printing" feature saves you from repeatedly having to enter how many copies to print by assigning the number of copies per set in advance. Previous models allowed separation of printed copies into 50 groups, but with the ME9350 you can set up to 150 groups for your print jobs. Operation stops after printing each set of copies. The RISO Job Separator IV:NIII, an optional feature on the RISO ME9350 digital duplicator, enables tape to be inserted between printing jobs even during high-speed printing and speedily separates the printed paper into lots of specified numbers, all without interrupting the printing process.



The RISO Job Separator IV:NIII
When combined with the "Programmed printing" function, it distinguishes between different printing jobs and separates the printed paper into groups accordingly.

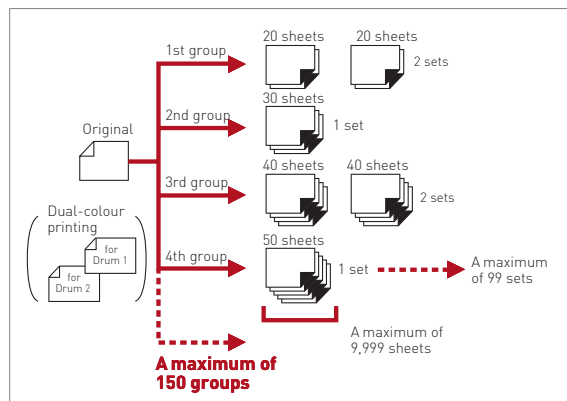

Reliable security features for your peace of mind.

By registering the names and PIN codes of authorised users, access can be restricted and misuse prevented. Instead of a PIN code, a USB flash drive*1 can also be used for authentication and registration.*2 The Protect function displays a message asking the user to transfer the master to the Master Disposal Box after printing is completed. For additional security, it is also possible to use a padlock to secure the Master Disposal Box.*3

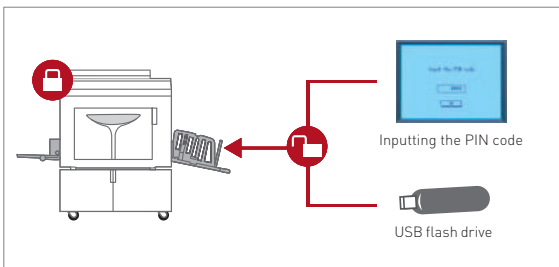

Note: A maximum of 100 users, including the administrator, can be registered.

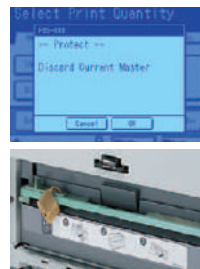

Master Disposal Box

*1 Please contact a RISO sales executive for the kinds of USB flash drives that may be used.
*2 Either a PIN code or a USB flash drive can be selected as the authentication method.
*3 A padlock is not provided with the main unit. Please use a commercially available padlock.

Keep track of the unit's usage stats with accurate monitoring functions.

The "RISO Copy Count Viewer" manages the counter data (number of prints, masters, etc.) output to a USB drive from your computer.

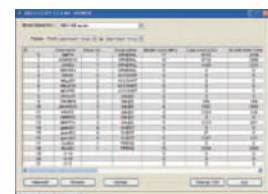

Smart, easy, and versatile: Two-colour printing the way you want it.

Full expandability to give you the functions you need.



Colour drum
A wide variety of colours is available. Drums can be stored in their own cases.



Auto document feeder AF-VI:II
Automatic feed of up to 50 sheets of originals.



Auto document feeder DX-1
Automatic scanning of both sides of originals and automatic feeding. 50-sheet capacity.



Card feed kit
Allows use of thicker stock such as cards and envelopes.



Job Separator IV:N III
Allows the machine to print and sort into groups separated by tape.



RISO stand D type (II)
Provides storage for up to two optional print drums, inks, and masters.



RISO stand N type (II)
Sturdy open-front stand also offers convenient storage of consumables.



RISO controller IS300
Provides compatibility with Adobe® PostScript®3™.

Network card
Gives the printer a network connection. Comes bundled with RISO-MONITOR remote printer-monitoring software.

Document storage card DM-128CF/DM-512CF
Allows storage of frequently used documents for instant recall.

Envelope feeder
Compatible with paper weight 50 gsm to 120 gsm.
*Please contact a RISO sales executive for the kinds of envelope that may be used.

RISO Printer driver for Macintosh
Printer driver on CD for Mac OS.
Wide-stacking tray
Allows use of paper up to 555 mm from top to bottom.

A complete range of RISO ME Series supplies.



RISO Ink
You can choose from 21 standard colours, 50 custom colours, or an unlimited number of special order-made colours—ideal for applications such as specific corporate colours.

Ink
RISO INK ETYPE HD BLACK
RISO INK ETYPE COLOR



RISO Master
High-quality RISO masters provide the best performance match with ME series printers, giving a sharp, clear image to all your documents.

Master
RISO MASTER ETYPE HG 97
RISO MASTER ETYPE HD 87

RISO iQualitySystem™

The RISO iQuality System™ offers a large number of quality and convenience benefits.

Among them are:

- Automatic assurance of optimum print quality.
- Prevention of operator error.
- Warning of shortages in remaining ink/master volume.
- Minimised paper waste.



The RISO iQuality mark indicates a RISO product compatible with the RISO iQuality System.

Helps to save both energy and resources.

Recycled parts

Ink bottles and some parts for the ME series are made partially from recycled components.

ENERGY STAR® Program



Compliant with an international program that promotes energy saving in printing machines. The program sets standards in terms of the power consumption of printing machines.

RoHS Directive

Compliant with the European Union directive on the restriction of the use of certain hazardous substances in electrical and electronic equipment.

Energy-efficient printing

The digital duplicator uses no toner and therefore needs no source of heat to affix the toner in the print process. Turn the duplicator on and it's ready to go in an instant, letting you save energy whenever it's not in use. And high-speed printing means your job is done sooner, so you can turn it off that much more quickly.

RISO Ink is made of eco-friendly soy oil

One of the ingredients of RISO INK is soy oil, making it a high-quality, eco-friendly product. It meets the soy oil content standards specified by the American Soybean Association and is certified to use the "CONTAINS SOYOIL" trademark.



Note: Order-made colours may not be available in soy-oil-based inks.

RISO ME 9350

Specifications are subject to change without notice. Details may vary depending on the region.

- *1 When installed with RISO Auto document feeder DX-1.
- *2 When installed with RISO Auto document feeder AF-VI:II.

Note: All dimensions are when installed with RISO stand D type (III).

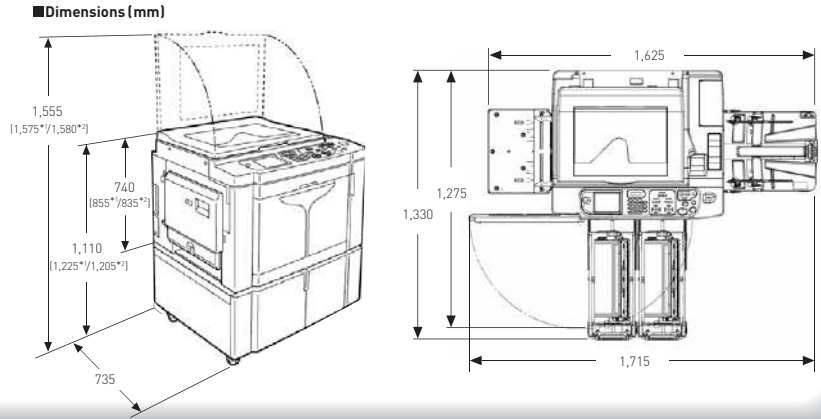

RISO ME9350 Specifications

Master-making/printing methods	High-speed digital master-making/full automatic stencil printing	
Original Type	Book (10 kg [22 lb] or less), sheet	
Resolution	Scanning resolution:	600 dpi × 600 dpi
	Printing image resolution:	600 dpi × 600 dpi
Original Size (min./max.)	When using the Glass Platen:	50 mm × 90 mm [1 ³¹ / ₃₂ " × 3 ¹⁷ / ₃₂ "] - 310 mm × 432 mm [12 ⁷ / ₃₂ " × 17"]
	When using the Auto Document Feeder AF-VI:II (option):	100 mm × 148 mm [3 ¹⁵ / ₁₆ " × 5 ¹³ / ₁₆ "] - 310 mm × 432 mm [12 ⁷ / ₃₂ " × 17"]
	When using the Auto Document Feeder DX-1 (option):	105 mm × 128 mm [4 ¹ / ₈ " × 5 ¹ / ₃₂ "] - 297 mm × 432 mm [11 ¹¹ / ₁₆ " × 17"]
Original Paper Weight	When using the Auto Document Feeder AF-VI:II (option):	50 gsm (13-lb bond) - 128 gsm (34-lb bond)
	When using the Auto Document Feeder DX-1 (option):	Single-sided feeding: 40 gsm (11-lb bond) - 128 gsm (34-lb bond) Duplex-sided feeding: 52 gsm (14-lb bond) - 105 gsm (28-lb bond)
Printing Paper Size (min./max.)	Minimum size	
	- Dual-Color Print	182 mm × 257 mm [7 ⁵ / ₃₂ " × 10 ¹ / ₈ "]
	- Mono-Color Print (with Print Drum 1)	100 mm × 148 mm [3 ¹⁵ / ₁₆ " × 5 ¹³ / ₁₆ "]
	- Mono-Color Print (with Print Drum 2)	182 mm × 257 mm [7 ⁵ / ₃₂ " × 10 ¹ / ₈ "]
	Maximum size	320 mm × 432 mm [12 ¹⁹ / ₃₂ " × 17"]*
	*Paper up to 555 mm [21 ²⁷ / ₃₂ "] from top to bottom may be used in the Extended Paper mode.	
Paper Supply Capacity	Approx. 1,000 sheets [80 gsm (21-lb bond)] /Maximum Height 110 mm [4 ¹¹ / ₃₂ "	
Paper Receiving Capacity	Approx. 1,000 sheets [80 gsm (21-lb bond)] /Maximum Height 110 mm [4 ¹¹ / ₃₂ "	
Printing Paper Weight	46 gsm (12-lb bond) - 210 gsm (110-lb index)	
Image Processing Mode	Line, Photo (Standard/Portrait/Group), Duo (Line/Photo/Shadow off), Pencil (Darker/Lighter)	
Master-making Time (for A4/short edge feed/ 100% reproduction ratio)	Approx. 57 seconds (for Dual-Color print) Approx. 24 seconds (for Mono-Color print (Drum 1)) Approx. 34 seconds (for Mono-Color print (Drum 2, when Print Drum 1 is not set))	
Printing Area (max.)	291 mm × 413 mm [11 ¹⁵ / ₃₂ " × 16 ¹ / ₄ "	
Print Reproduction Ratio	Zoom: 50 - 200% Standard reproduction ratio (enlargement): 163%, 141%, 122%, 116% Standard reproduction ratio (reduction): 87%, 82%, 71%, 61% Margin+: 90 - 99%	
Print Speed	60 - 120 sheets per minute (Control panel: five steps variable) /150 sheets per minute (Touch panel: "High Speed")	
Print Position Adjustment	Vertical: ±15 mm [± ¹⁹ / ₃₂ "] Horizontal: ±10 mm [± ²⁵ / ₆₄ "	
Ink Supply	Fully automatic (1,000 ml per cartridge)	
Master Supply/Disposal	Fully automatic (approx. 220 sheets per roll)	
Master Disposal Capacity	80 sheets per box	
User Interface	LCD Touch Panel with Progress Arrow indicators	
Operating Noise	Max. 66 dB(A) (when printing 100 sheets per minute)	
Power Source	ME9350E: AC 220-240 V, 50-60 Hz <3.0 A> / ME9350A: AC 100-240 V, 50-60 Hz <7.3-3.0 A>	
Power Consumption (without option)	Max. 600 W (100 V) / 580 W (220 V) At Ready: approx. 53 W (100 V, 220 V) At Sleep: approx. 2.0 W (100 V, 220 V)	
Functions	Print Mode (Dual-color/Mono-color), Auto Document Feeder (optional), Direct Print, Scanning Contrast [Manual/Auto], Paper Size detection, Auto-Process, Dot Process (4 types), Contrast Adjustment, Tone Curve, Ink Saving, Multi-Up Print (2 up/Single-Original/ Multiple-Original/Multi-Up Tickets), Layout, Book Shadow, Top Margin, Binding Margin, Max. Scan, Easy 2-Color, Preview, OneSide MasterMake, Print Speed Adjustment, Print Density Adjustment, Print Position Adjustment, 1=2 Alignment, Proof, Double Feed Check, Interval Printing, Jump Wing Control, Special Paper Control, User Management, Programmed Printing (3 types), Job Memory, Confidential mode, Reservation, Idling, Renew Page, Output Reversal, ADF Semi-Auto (with optional ADF unit installed), Scanning Side (with optional ADF DX-1), Rotate, ID Counter Report, My Direct Access, Admin. Mode, Auto 90° Rotation, SW. Color, Energy Saving Mode (Auto Sleep, Auto Power-OFF), Editor, Direct Access Entry, Selections Entry, Custom Paper Entry, Protect, Scan Mode (with optional memory card or USB Flash Drive), Storage memory (with optional memory card), USB Job List (with USB Flash Drive), Overlay (with optional memory card or USB Flash Drive), Stamp, Management of Consumables, RISO i Quality System	
Dimensions	When in use: 1,625 mm (W) × 735 mm (D) × 740 mm (H) [63 ³¹ / ₃₂ " (W) × 28 ¹⁵ / ₁₆ " (D) × 29 ¹ / ₈ " (H)] When in storage: 1,005 mm (W) × 735 mm (D) × 740 mm (H) [39 ⁹ / ₁₆ " (W) × 28 ¹⁵ / ₁₆ " (D) × 29 ¹ / ₈ " (H)]	
Required Space*1	1,715 mm (W) × 1,330 mm (D) × 1,555 mm (H) [67 ¹⁷ / ₃₂ " (W) × 52 ⁷ / ₈ " (D) × 61 ⁷ / ₃₂ " (H)]	
Weight*2	Approx. 170 kg (375 lb)	
Safety Standard	IEC-60950-1 compliant, Indoor, pollution degree 2*3, At altitudes of 2,000 m or lower	

Note: • Please note that due to improvements and changes to the machine, some images and explanations in this manual may not correspond to your machine.
• The specifications are subject to change without prior notice.

*1 The height includes the height of the RISO stand D type (III).

*2 The weight does not include Ink and Master.

*3 The pollution degree of the usage environment due to dirt and dust in the air. Degree "2" corresponds to general indoor environment.

RISO logo, RISO i Quality System™ and  are either registered trademarks or trademarks of RISO KAGAKU CORPORATION. Adobe and PostScript are either registered trademarks or trademarks of Adobe Systems Incorporated in the United States and/or other countries. Mac OS is a trademark of Apple, Inc.



RISO KAGAKU CORPORATION
<http://www.riso.com/>

For more details please contact:

